



**YANMAR**

ZERO TAIL SWING MINI EXCAVATOR

# **Vi017**

[Gross] 10.1kW <13.5hp>



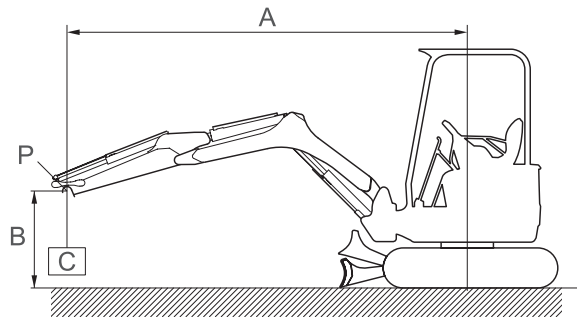

\* The machine in the picture is equipped with optional parts.

# Lifting Capacity











With:  
Canopy Type  
Rubber Crawler  
Without: Bucket

- A : Reach from swing center line [m<in.>]
- B : Load point height [m<in.>]
- C : Lifting load [kg<lbs.>]
- P : Load point
-  : Rating over front
-  : Rating over side or 180 degrees









Blade on ground

Unit : kg <lbs.>

A [m.<in.>]	Max.		2.5<98.4>		2.0<78.7>		Min.	
B [m.<in.>]								
2.0<78.7>	340 *<749>	240 <529>	320 *<705>	315 *<694>	-	-	-	-
1.5<59.1>	350 *<771>	220 <485>	370 *<815>	370 *<815>	425 *<936>	420 *<925>	-	-
1.0<39.4>	365 *<804>	205 <451>	450 *<992>	305 <672>	595 *<1311>	440 <970>	665 <1466>	555 <1223>
0.5<19.7>	375 <826>	205 <451>	525 *<1157>	300 <661>	740 *<1631>	425 <936>	920 *<2028>	505 <1113>
0<0>	390 *<859>	205 <451>	550 *<1212>	285 <628>	765 *<1686>	400 <881>	1050 *<2314>	505 <1113>
-0.5<-19.7>	410 *<903>	230 <507>	545 *<1201>	290 <639>	735 *<1620>	400 <881>	-	-
-1.0<-39.4>	420 *<925>	270 <595>	-	-	680 *<1499>	405 <892>	-	-

Blade above ground

Unit : kg <lbs.>

A [m.<in.>]	Max.		2.5<98.4>		2.0<78.7>		Min.	
B [m.<in.>]								
2.0 <78.7>	225 <496>	235 <518>	315 *<694>	315 *<694>	-	-	-	-
1.5<59.1>	205 <451>	215 <473>	305 <672>	370 *<815>	420 *<925>	425 *<936>	-	-
1.0<39.4>	185 <407>	200 <440>	285 <628>	295 <650>	410 <903>	435 <959>	525 <1157>	550 <1212>
0.5<19.7>	185 <407>	200 <440>	280 <617>	295 <650>	390 <859>	415 <914>	470 <1036>	500 <1102>
0<0>	190 <418>	205 <451>	265 <584>	285 <628>	365 <804>	385 <848>	520 <1146>	495 <1091>
-0.5<-19.7>	210 <462>	225 <496>	260 <573>	280 <617>	355 <782>	385 <848>	-	-
-1.0<-39.4>	250 <551>	265 <584>	-	-	375 <826>	405 <892>	-	-

Note :

The lifting load with the asterisk (<\*>) mark is limited by hydraulic lifting capacity rather than tipping. The lifting capacity shown in the above list is based on the ISO Standard No. 10567 and represents either 87% of hydraulic lifting capacity or 75% of the tipping load, which is smaller.

● Dimensions

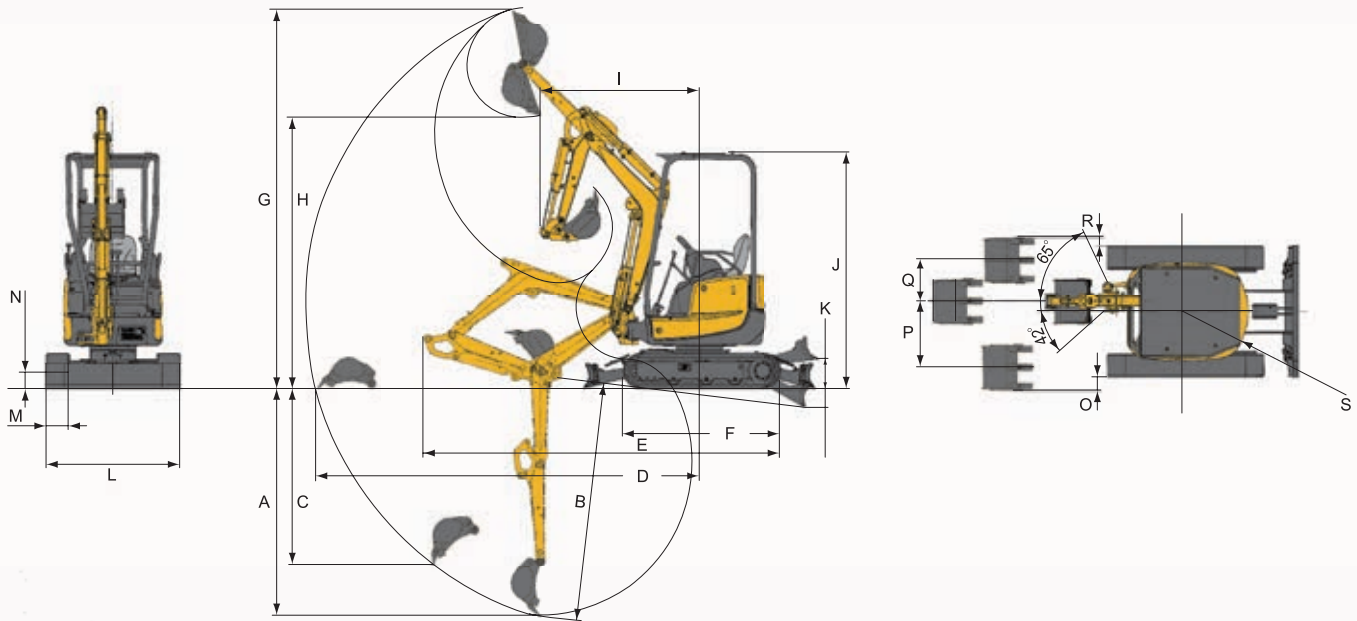

(unit: mm(ft-in))

	A	B	C	D	E	F	G	H	I	J	K	L	M	N	O	P	Q	R	S
Vi017	2200 (7'03")	2310 (7'7")	1850 (6'1")	3710 (12'2")	3450 (11'4")	1525 (5'0")	3690 (12'1")	2630 (8'8")	1535 (5'0")	2300 (7'7")	260 (10")	950(3'1") 1280(4'2")	230 (9")	175 (7")	125 (5")	640 (2'1")	400 (1'4")	85 (3")	R640 (2'1")

Specifications

Model		Vi017	
Type		Canopy	
Operating Weight	Rubber track	1740 (3836) kg (lbs)	
	Steel track	1800 (3969) kg (lbs)	
Engine	Type	Vertical 3 cylinder water-cooled diesel	
	Model	3TNV70-XBV	
	Rated Output	10.1 (13.5) / 2200 kW (hp) / rpm	
Performance	Bucket capacity, standard (ISO heaped)	0.05 (1.77) cu.m (cu.ft)	
	Max Digging Force	Bucket	15.2 (3417) kN (lbf)
		Arm	8.5 (1918) kN (lbf)
	Traveling Speed, High/Low	4.3 / 2.1 (2.7 / 1.3) km/h (MPH)	
	Swing Speed	9.5 RPM	
Boom Swing Angle, (L / R)	42 / 65 degrees		
Ground Contact Pressure	Rubber track	28.6 (4.1) kPa (PSI)	
	Steel track	29.6 (4.3) kPa (PSI)	
Hydraulic System	Pump Capacity	17.6 + 17.6 + 13.2 + 11.2 (4.6 + 4.6 + 3.5 + 2.6) L / min (GPM)	
	Main Relief Set Pressure	20.6 (2987) MPa (PSI)	
Undercarriage	Track type	Rubber	
Blade Dimensions	Width x Height	1280 / 950 x 235 (4'2" / 3'1" x 9") mm (ft-in)	
Fuel tank capacity	L (Gals)	20 (5.3)	

Hydraulic P.T.O.

Model		Vi017	
Specification	Output	MPa (PSI)	L / min (GPM)
			2200RPM
Combined Flow, Double Actions		16.7 (2417)	30.8 (8.1) / 17.5 (4.6)

YANMAR CONSTRUCTION EQUIPMENT CO., LTD.

Promotion Group  
 Sales Planning Dept.  
 Marketing & Sales Dept.  
 1717-1, Oaza Kumano, Chikugo, Fukuoka 833-0055, Japan  
 TEL. +81-942-70-8992  
 FAX +81-942-53-6855  
 yanmar.com

All data subject to change without notice.